

## INDUSTRY CANADA STATEMENT

This device complies with Innovation, Science and Economic Development Canada licence-exempt RSS standard(s).

Operation is subject to the following two conditions:

- (1) this device may not cause interference, and
  - (2) this device must accept any interference, including interference that may cause undesired operation of the device.
- CAN ICES-3(B)/NMB-3(B)

Le présent appareil est conforme aux CNR Innovation, Sciences et Développement économique Canada applicables aux appareils radio exempts de licence. L'exploitation est autorisée aux deux conditions suivantes:

- (1) il ne doit pas produire de brouillage et
  - (2) l'utilisateur du dispositif doit être prêt à accepter tout brouillage radioélectrique reçu, même si ce brouillage est susceptible de compromettre le fonctionnement du dispositif.
- CAN ICES-3(B)/NMB-3(B)

The device meets the exemption from the routine evaluation limits in section 2.5 of RSS 102 and compliance with RSS-102 RF exposure, users can obtain Canadian information on RF exposure and compliance.

Le dispositif rencontre l'exemption des limites courantes d'évaluation dans la section 2.5 de RSS 102 et la conformité à l'exposition de RSS-102 rf, utilisateurs peut obtenir l'information canadienne sur l'exposition et la conformité de rf.

This transmitter must not be co-located or operating in conjunction with any other antenna or transmitter. This equipment should be installed and operated with a minimum distance of 5 millimeters between the radiator and your body.

Cet émetteur ne doit pas être Co-placé ou ne fonctionnant en même temps qu'aucune autre antenne ou émetteur. Cet équipement devrait être installé et actionné avec une distance minimum de 5 millimètres entre le radiateur et votre corps.



## FEDERAL COMMUNICATION COMMISSION INTERFERENCE STATEMENT

Caution: If any changes or modifications not expressly approved by the party responsible for compliance could void the user's authority to operate the equipment. This device complies with Part 15 of the FCC Rules.

Operation is subject to the following two conditions:

- (1) This device may not cause harmful interference, and
- (2) This device must accept any interference received, including interference that may cause undesired operation.

The grantee is not responsible for any changes or modifications not expressly approved by the party responsible for the compliance. Such modifications could void the user's authority to operate the equipment.

The RF Exposure Compliance distance is 5 millimeters.

NOTE: This equipment has been tested and found to comply with the limits for a Class B digital device, pursuant to part 15 of the FCC Rules. These limits are designed to provide reasonable protection against harmful interference in a residential installation. This equipment generates, uses and can radiate radio frequency energy and, if not installed and used in accordance with the instructions, may cause harmful interference to radio communications. However, there is no guarantee that interference will not occur in a particular installation. If this equipment does cause harmful interference to radio or television reception, which can be determined by turning the equipment off and on, the user is encouraged to try to correct the interference by one or more of the following measures:

- Reorient or relocate the receiving antenna.
- Increase the separation between the equipment and receiver.
- Connect the equipment into an outlet on a circuit different from that to which the receiver is connected.
- Consult the dealer or an experienced radio/TV technician for help.

FCC ID: M5LSPD3STS



## EU-DECLARATION OF CONFORMITY

We, SIGMA-ELEKTRO GmbH, Dr.-Julius-Leber-Str. 15, D-67433 Neustadt/Weinstraße declare under our responsibility that the transmitter STS-S-3 are compliant with the essential requirements and other relevant requirements of the RED Directive 2014/53/EU and the RoHS Directive 2011/65/EU. The declaration of conformity can be found at: [ce.sigmasport.com/ats2021](http://ce.sigmasport.com/ats2021)

## EU-KONFORMITÄTSERKLÄRUNG

Wir, SIGMA-ELEKTRO GmbH, Dr. Julius Leber Str. 15, D-67433 Neustadt/Weinstraße erklären, dass der Sender STS-S-3 bei bestimmungsgemäßer Verwendung den grundlegenden Anforderungen gemäß RED Directive 2014/53/EU und der RoHS Directive 2011/65/EU entspricht. Sie finden die Konformitäts-Erklärung unter folgendem Link: [ce.sigmasport.com/ats2021](http://ce.sigmasport.com/ats2021)

## UKCA STATEMENT



We, SIGMA-ELEKTRO GmbH, declare that the equipment above has been tested in our facility and found compliance with the requirement limits of applicable standards, in accordance with the Radio Equipment Regulations 2017 and the Restriction of the Use of Certain Hazardous Substances in Electrical and Electronic Equipment Regulations 2012. The test record, data evaluation and Equipment Under Test (EUT) configurations represented herein are true and accurate under the standards herein specified.

## TECHNICAL INFORMATION

Battery type	CR 2032 x 3 V
Operation temperature	-10 °C to 60 °C
Operation frequency	112 kHz
Transmission power	Max power <11.37 dBm

[sigmasport.com](http://sigmasport.com)

**SIGMA-ELEKTRO GmbH**

Dr.-Julius-Leber-Straße 15  
67433 Neustadt/Weinstraße  
Germany

080541/2



**SIGMA**

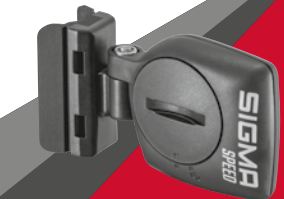

**SPEED TRANSMITTER  
STS**

## INSTALLATION WIRELESS SPEED TRANSMITTER

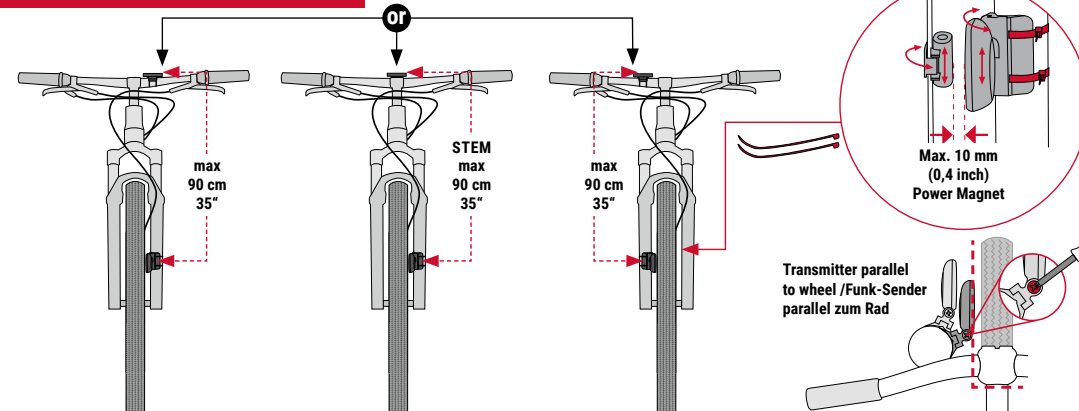

## SWITCH FROM BIKE 1 TO BIKE 2

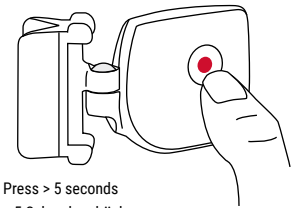

- EN** Press > 5 seconds
- DE** > 5 Sekunden drücken
- FR** > Maintenir la touche enfoncée pendant 5 secondes
- IT** Premere > 5 secondi
- ES** Presionar > 5 segundos
- PT** > Premir durante 5 segundos
- NL** > 5 seconden indrukken
- PL** Naciskać >5 sekund
- CZ** Stisknutí > 5 sekund

### BIKE 1

- EN** Green LED is flashing
- DE** Grüne LED blinkt
- FR** La LED verte clignote
- IT** Il LED verde lampeggia
- ES** El LED verde parpadea
- PT** LED verde intermitente
- NL** Groene LED knippert
- PL** Zielona LED miga
- CZ** Zelená LED bliká

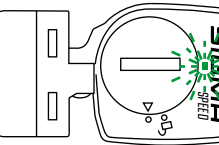

### BIKE 2

- EN** Red LED is flashing
- DE** Rote LED blinkt
- FR** La LED rouge clignote
- IT** Il LED rosso lampeggia
- ES** El LED rojo parpadea
- PT** LED vermelho intermitente
- NL** Rode LED knippert
- PL** Czerwona LED miga
- CZ** Červená LED bliká

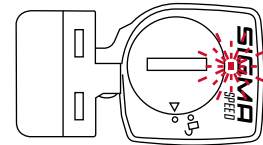

## BATTERY CHANGE

1

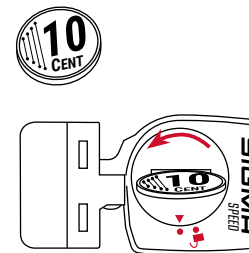

2

Battery: CR 2023

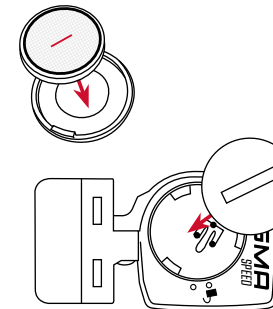

3

